

SECTION B-B

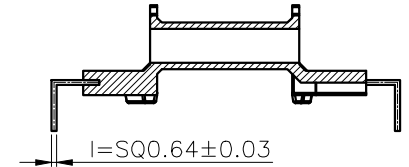

SECTION A-A

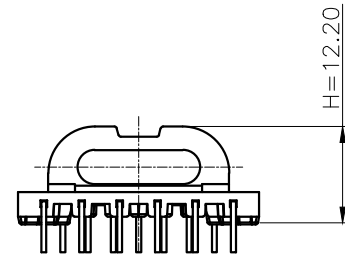
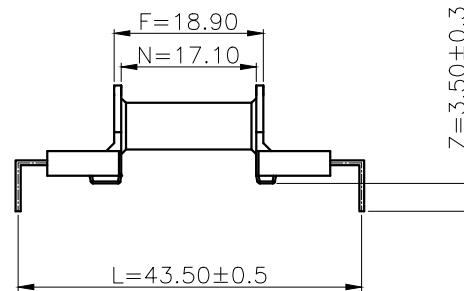
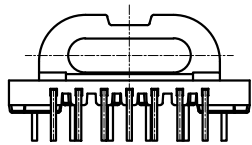
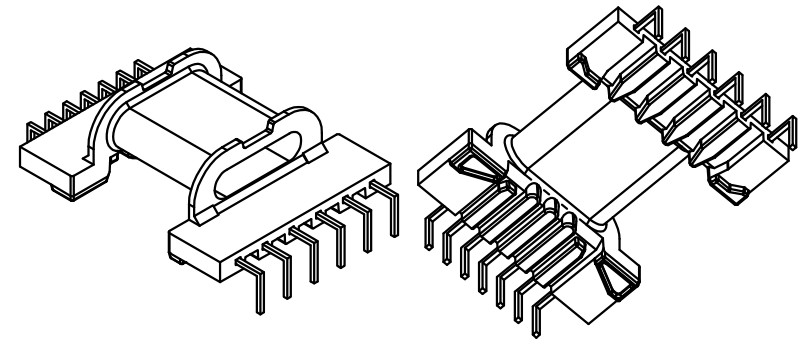
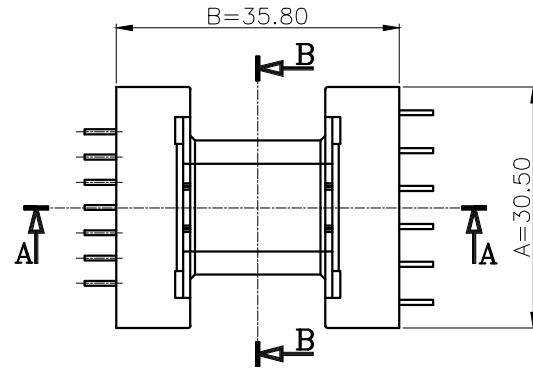
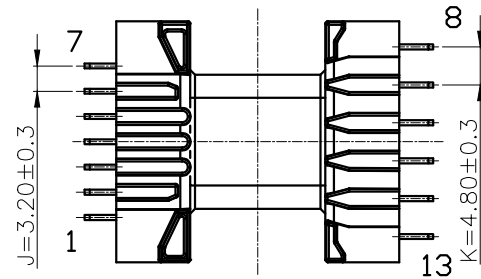

REVISION NOTE						
MARK						
DRAWN	CHECKED	APPROVED	MATERIAL : PHENOL	UL REC. : UL94V-0	THIRD ANGLE PROJ.	SCALE : 1/1
HK, Yang	Hyung Seok, Lee	Chul, Park		DATE : 2012.01.31	TOLERANCE : ±0.2 (Unless otherwise specified)	UNIT : m/m
주식회사 대흥보빈 DAE HEUNG BOBBIN CO., LTD.			TITLE EPC 30*28 "H" (13P) (B)		DWG NO DH-120313-8602-02	